

SIRRO

26-11-2015

2.0 LED - ceiling surfaced

LED 2x10W | 220-240VAC | 50-60Hz | COB 3-step | incl. PS | phase-cut dim
 CE \oplus IP20 $\text{960}^\circ\text{C}$ 0,3m P $\text{A}36^\circ$ $\text{J}35^\circ/35^\circ$ $\text{C}355^\circ$

white texture
 white texture + black
 aluminium brushed + black

139264W_
 139264E_
 139264F_

LIGHT COLOUR

2200K | >80CRI | 465lm 1
 2700K | >90CRI | 590lm 3
 3000K | >90CRI | 640lm 5

2.0 PAR16 - ceiling surfaced

PAR16 2xPAR16 max. 35W | GU10 | 220-240VAC | 50-60Hz
 CE \oplus IP20 $\text{960}^\circ\text{C}$ 0,9m $\text{J}35^\circ/35^\circ$ $\text{C}355^\circ$

white texture

139220W0

OPTIONAL

for PAR16 lamps see our catalogue

2.0 LED - suspended

LED 2x10W | 220-240VAC | 50-60Hz | COB 3-step | incl. PS | phase-cut dim
 CE \oplus IP20 $\text{960}^\circ\text{C}$ 0,3m P $\text{A}36^\circ$ $\text{J}35^\circ/35^\circ$ $\text{C}355^\circ$

white texture
 white texture + black
 aluminium brushed + black

139664W_
 139664E_
 139664F_

LIGHT COLOUR

2200K | >80CRI | 465lm 1
 2700K | >90CRI | 590lm 3
 3000K | >90CRI | 640lm 5

2.0 PAR16 - suspended

PAR16 2xPAR16 max. 35W | GU10 | 220-240VAC | 50-60Hz
 CE \oplus IP20 $\text{960}^\circ\text{C}$ 0,9m $\text{J}35^\circ/35^\circ$ $\text{C}355^\circ$

white texture

139620W0

OPTIONAL

for PAR16 lamps see our catalogue

②

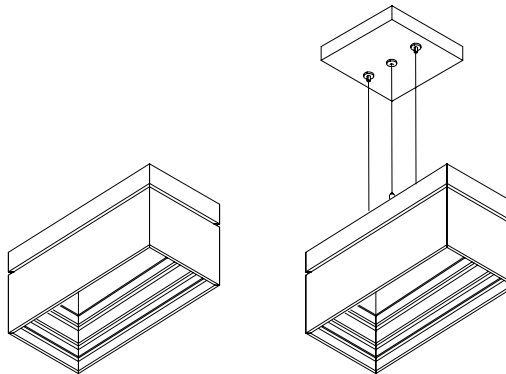

③

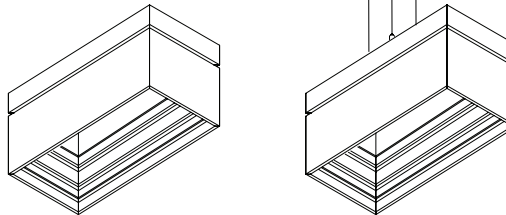

④

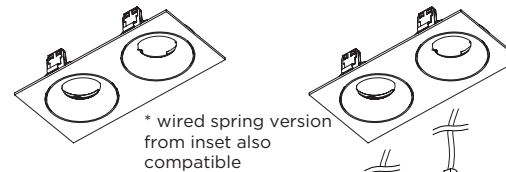

⑤

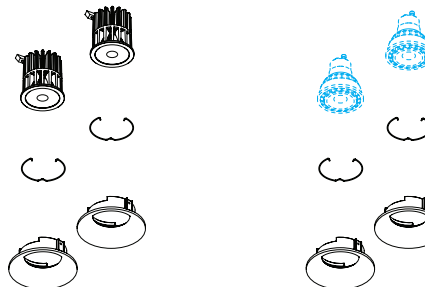

⑥



DIMENSIONS

CEILING SURFACED

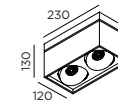

SUSPENDED

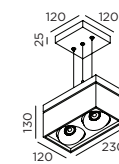

BASE PLATE DIMENSIONS

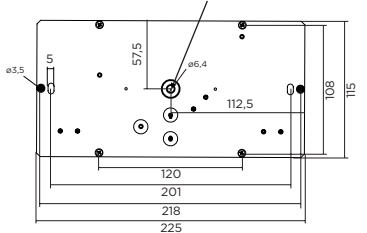

POWER CABLE ENTERS HERE

MOUNTING INSTRUCTION

POWER CONNECTION

① PARALLEL CONNECTION - for LED and PAR16

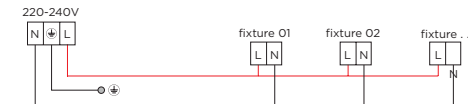

② Mount the ceiling base on the ceiling

③ Attach the SIRRO to the ceiling base (in case of surfaced version)

④ Insert the outer part of the inset module into the SIRRO

⑤ Insert the lamps into the inner parts of the inset module

⑥ Click the inner part of the inset module into the outer part



WEVER & DUCRÉ
 LIGHTING

www.weverducre.com

INSTALLATION
 INSTRUCTIONS