

1 PHASE TRACKS

29-04-2019

GLOBAL 1 PHASE TRACK COMPONENTS - OVERVIEW

With below components we can make a lot of different compositions.

End feed



GB11 (LEFT)

90014018
90014019



GB12 (RIGHT)

90014020
90014021

Middle feed



GB14

90014036
90014037

Straight connector



GB21

90014022
90014023

L-connector



GB35 (RIGHT)

90014026
90014027



GB34 (LEFT)

90014024
90014025

— = indicates ground

T-connector

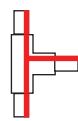

GB40

90014010
90014011

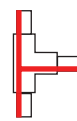

GB39

90014012
90014013

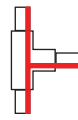

GB37

90014016
90014017

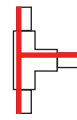

GB36

90014014
90014015

X-connector



GB38

90014049
90014050

Adjustable corner

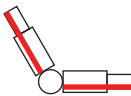

GB24

90014042
90014041

End cap



GB41

90014028
90014029

1 phase tracks

1M 2M 3M



1 Meter (surface)

90014001
90014007

2 Meter (surface)

90014002
90014008

3 Meter (surface)

90014003
90014009

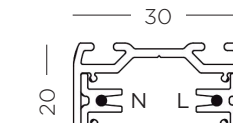
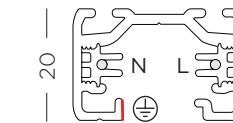

1 Meter (recessed)

90014118
90014119

2 Meter (recessed)

90014120
90014121

3 Meter (recessed)

90014122
90014123

FEEDS

A FEED is a part upon which the power cable has to be connected to provide the complete circuit with electricity.

GB11 - END FEED LEFT
GB12 - END FEED RIGHT
GB14 - MIDDLE FEED

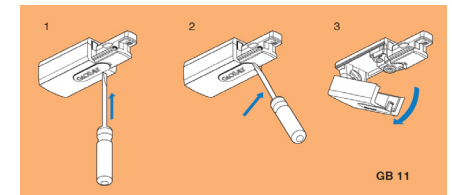

CONNECTORS

A connector is a part that passes the electricity from one track to another.

All connectors can be used as FEED except for those marked with a *

GB21 - STRAIGHT CONNECTOR *
GB34 - L-CONNECTOR LEFT
GB35 - L-CONNECTOR RIGHT
GB36 - T-CONNECTOR
GB37 - T-CONNECTOR
GB39 - T-CONNECTOR
GB40 - T-CONNECTOR
GB38 - X-CONNECTOR
GB24 - ADJUSTABLE CORNER *
GB41 - END CAP *

COMPATIBILITY

The 1-phase track components are compatible with most of the 1-phase tracks in the market as this is a standard.

drawings are made in top view

surface

recessed

drawings are made in top view



WEVER & DUCRÉ
LIGHTING

www.weverducre.com

Wever & Ducre bvba Spinnerijstraat 99/21 8500 Kortrijk

INSTALLATION
INSTRUCTIONS
PAGE 1/28

1 PHASE TRACKS

29-04-2019

GLOBAL 1 PHASE TRACK COMPONENTS - OVERVIEW (1/2)

Where can these components be found in the catalogue?

TRACK PROFILE 1M recessed

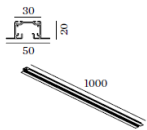

CODE
90014118
90014119

TRACK PROFILE 2M recessed

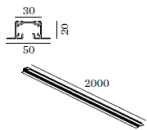

CODE
90014120
90014121

TRACK PROFILE 3M recessed

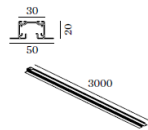

CODE
90014122
90014123

TRACK PROFILE 1M surface

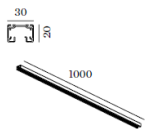

CODE
90014001
90014007

TRACK PROFILE 2M surface

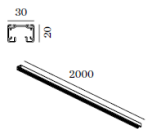

CODE
90014002
90014008

TRACK PROFILE 3M surface

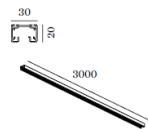

CODE
90014003
90014009

COVERPLATE I/L/T/X only use with recessed tracks

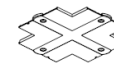

CODE
90014126
90014127

COVERPLATE END FEEDS only use with recessed tracks



CODE
90014124
90014125

END FEED left



CODE
90014018
90014019

END FEED right



CODE
90014020
90014021

CONNECTOR straight



CODE
90014022
90014023

L-CONNECTOR LEFT can be used as feed



CODE
90014024
90014025

L-CONNECTOR RIGHT can be used as feed



CODE
90014026
90014027

PAGE 602

PAGE 603



WEVER & DUCRÉ
LIGHTING

www.weverducre.com

Wever & Ducre bvba Spinnerijstraat 99/21 8500 Kortrijk

INSTALLATION
INSTRUCTIONS

PAGE 2/28

1 PHASE TRACKS

29-04-2019

GLOBAL 1 PHASE TRACK COMPONENTS - OVERVIEW (2/2)

Where can these components be found in the catalogue?

Page 605 represents the 3-phase tracks section but the "wire suspension" (marked in green) can also be used with the 1-phase tracks

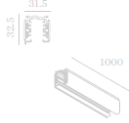
<p>MIDDLE FEED straight</p>  <p>CODE 90014036 90014037</p>				<p>END CAP LEFT/RIGHT</p>  <p>CODE 90014028 90014029</p>				<p>TRACK ADAPTER no space for driver for suspension power cable incl. strain relief</p>  <p>CODE 90014044 90014043</p>				<p>TRACK PROFILE 1M surface</p>  <p>CODE 90014060 90014061</p>		<p>TRACK PROFILE 2M surface</p>  <p>CODE 90014062 90014063</p>		<p>TRACK PROFILE 3M surface</p>  <p>CODE 90014064 90014065</p>	
<p>T-CONNECTOR can be used as feed</p>  <p>CODE 90014010 90014011</p>		<p>T-CONNECTOR can be used as feed</p>  <p>CODE 90014012 90014013</p>		<p>T-CONNECTOR can be used as feed</p>  <p>CODE 90014014 90014015</p>		<p>T-CONNECTOR can be used as feed</p>  <p>CODE 90014016 90014017</p>		<p>SUSPENSION CLAMP fast mounting</p>  <p>CODE 90014130 90014128</p>		<p>HEIGHT ADJ. SLEEVE</p>  <p>CODE 90014040</p>		<p>WIRE SUSPENSION incl. ceiling fixation bracket suitable also for 1-phase track</p>  <p>1.5m CODE 90014047 90014039</p> <p>3.0m CODE 90014053 90014082</p>					
<p>X-CONNECTOR can be used as feed</p>  <p>CODE 90014049 90014050</p>		<p>FLEXIBLE CORNER</p>  <p>CODE 90014042 90014041</p>		<p>HEIGHT ADJ. SLEEVE</p>  <p>CODE 90014040</p>		<p>SUSPENSION CLAMP</p>  <p>CODE 90014038</p>		<p>TRACK ADAPTER no space for driver for suspension power cable incl. strain relief</p>  <p>CODE 90014078 90014079</p>		<p>COMPLETE SUSPENSION SET incl. ceiling fixation</p>  <p>CODE 90014083</p>		<p>SUSPENSION WIRE SET cable with loop 3.0m</p>  <p>CODE 90014131 90014129</p>					

PAGE 604

PAGE 605

1 PHASE TRACKS

29-04-2019

HOW TO READ AND UNDERSTAND THE SYMBOLS?

All symbols are shown as top view

< REAL VIEW >

Realistic presentation

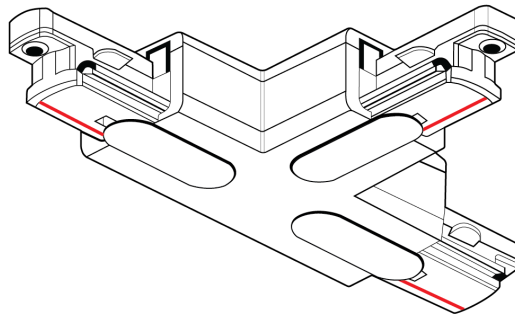

< TOP VIEW >

Schematic presentation

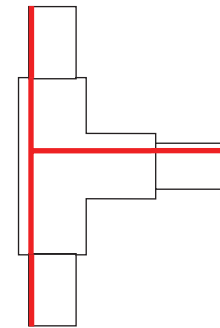

projected (top) view

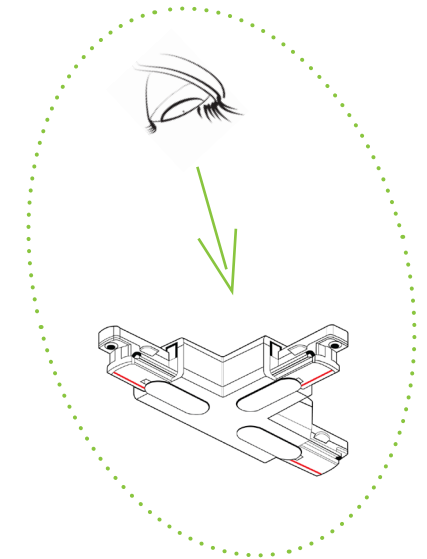

— = indicates ground

Simplified representation of the track components with a clear view where the polarity lines are located.

TOP VIEW (also called FLOOR VIEW):

The line drawings are seen and interpreted from above point of view.

1 PHASE TRACKS

29-04-2019

HOW TO MAKE A STRAIGHT LINE?

Depending on the polarity line of the tracks you have to choose between different types of connectors and feeds.

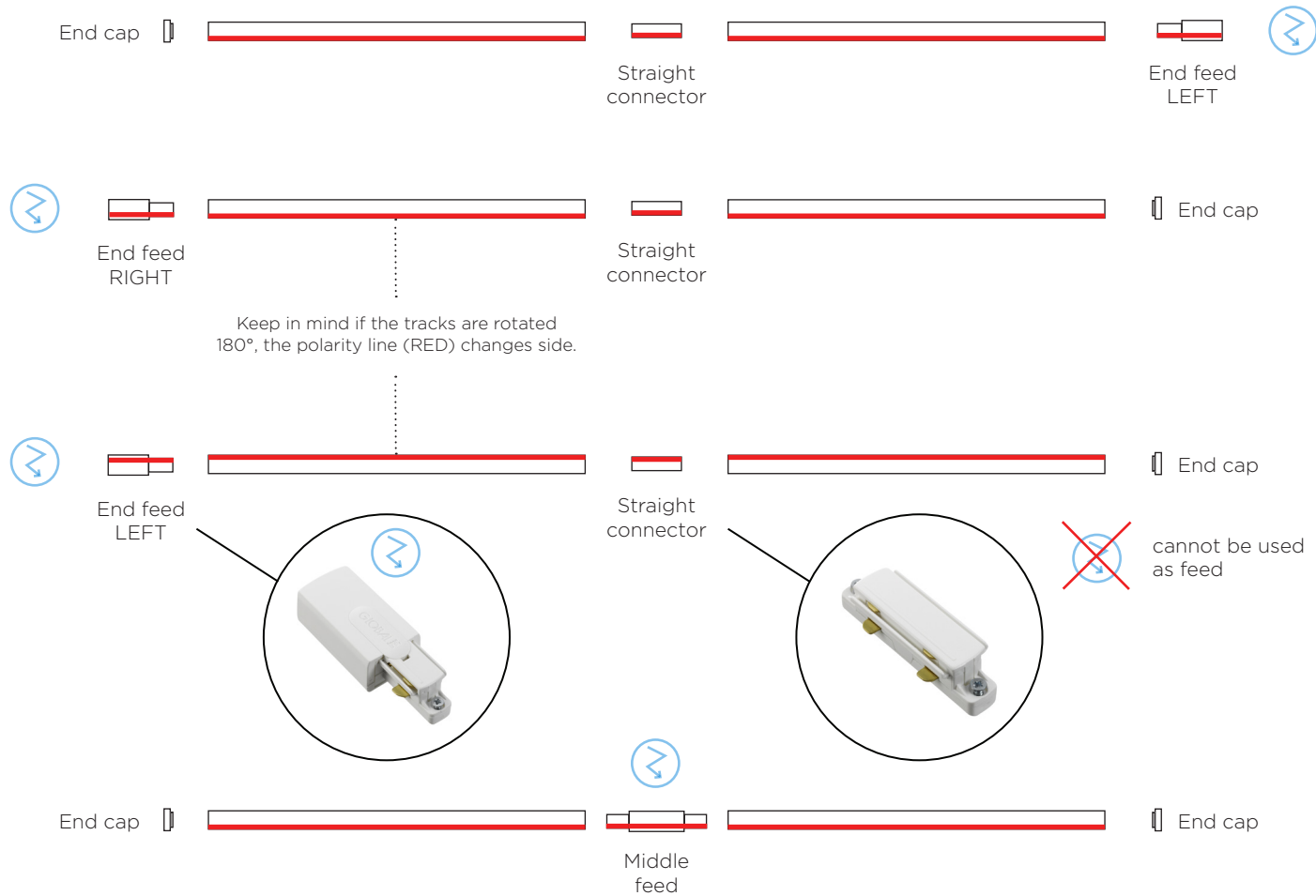

USED COMPONENTS

Middle feed



Straight connector



End feed



LEFT



RIGHT

End cap



— = indicates ground

= power connection (220-240VAC)

drawings are made in top view

Article codes on page 1-3

1 PHASE TRACKS

29-04-2019

INSTALLATION GUIDE - electrical connection to the track (1/2)

Connecting the power cable to the feeder unit in a proper way.

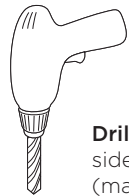
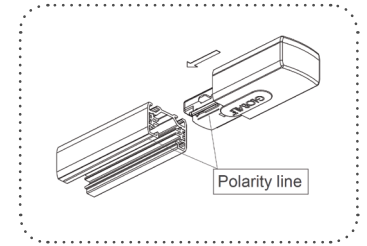

Drill a hole in the back-side of the component (marked with a circle)



Step 1



3 wires*

Insert the cable + connect to the connector block

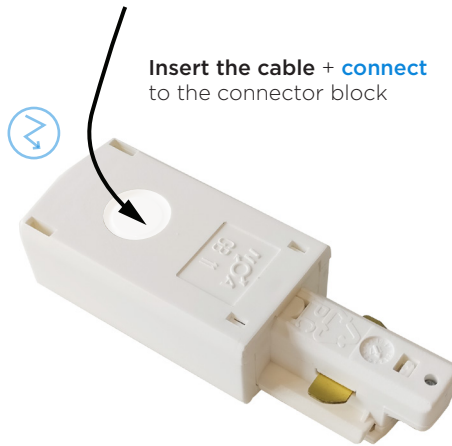

Step 2 (more info on page 7)

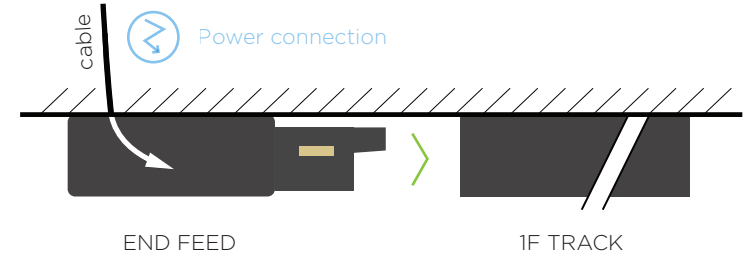

Step 3

Connect both component and the track to each other

*A 1 phase track enables you to make 1 electrical circuit only into 1 track system. Therefore a 3 wired cable is needed like shown below.

wire 1 > L1
wire 2 > N
wire 3 > Ground



1 PHASE TRACKS

29-04-2019

INSTALLATION GUIDE - electrical connection to the track (2/2)

Connecting the power cable to the feeder unit in a proper way.

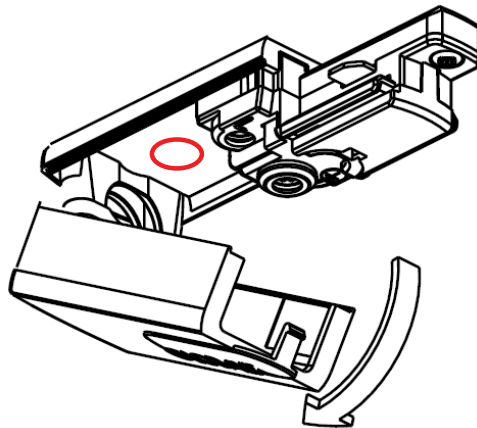
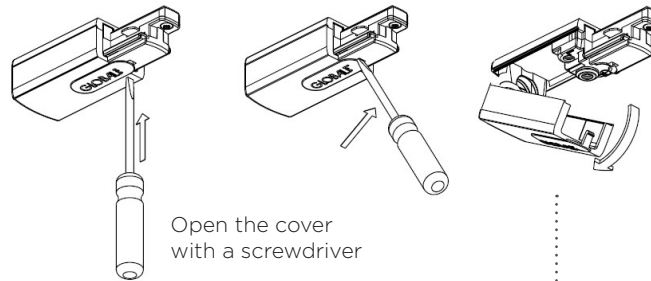

- > Make sure a hole is drilled in the backside
- > Open the cover

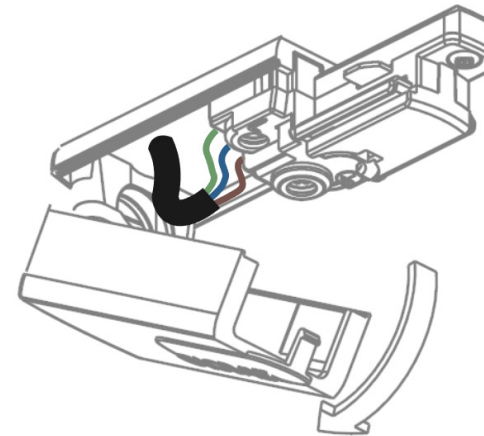

- > Put the cable through the hole and connect to the electrical block

1 PHASE TRACKS

29-04-2019

INSTALLATION GUIDE - connect multiple tracks to each other (mechanical & electrical)

In order to make a **mechanical and electrical connection** between 2 or more tracks, a straight connector is needed. This straight connector needs to slide inside both tracks until it's completely inside both tracks.

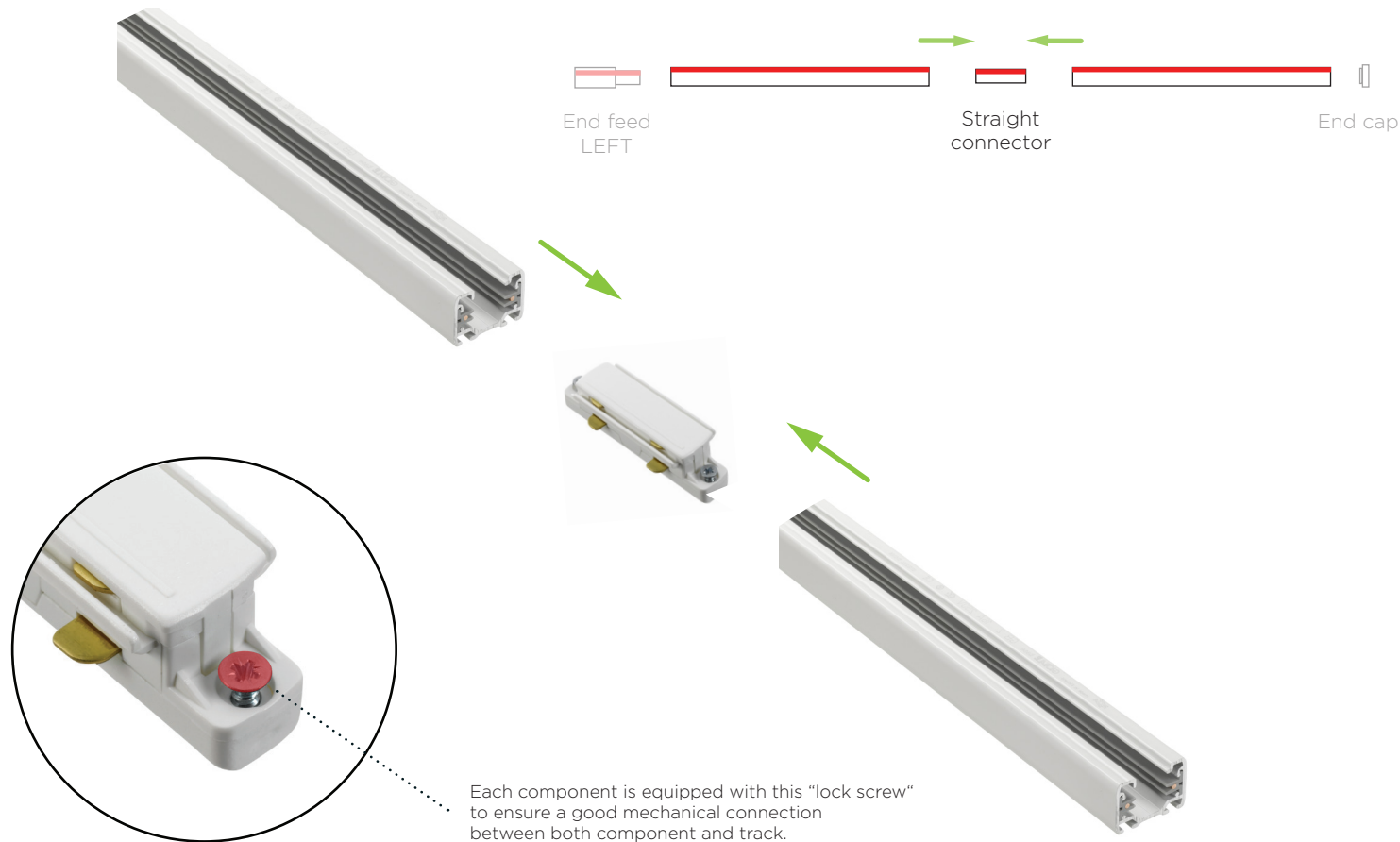



USED COMPONENTS

Straight connector

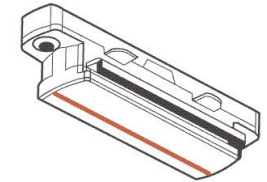
 GB21



 cannot be used as a feeder unit

 = indicates ground

 = power connection (220-240VAC)

Article codes on page 1-3

drawings are made in top view

1 PHASE TRACKS

29-04-2019

HOW TO MAKE A SQUARE? - when the power is located in one of the corners

When you make a composition of several corners and each corner turns in the same way like the ones before, you can keep using the same L-connector. In this composition each L-connector could be used as power feeder unit.

Only connect power to 1 single L-connector per circuit.

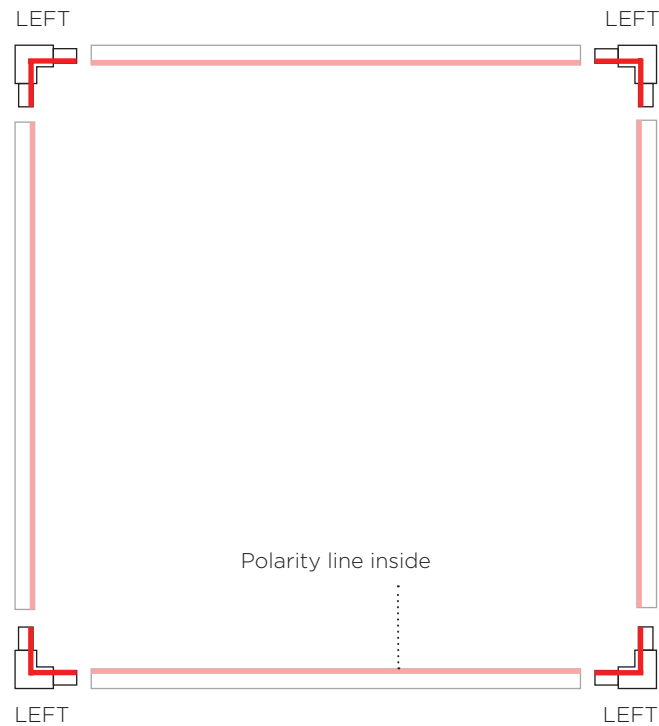
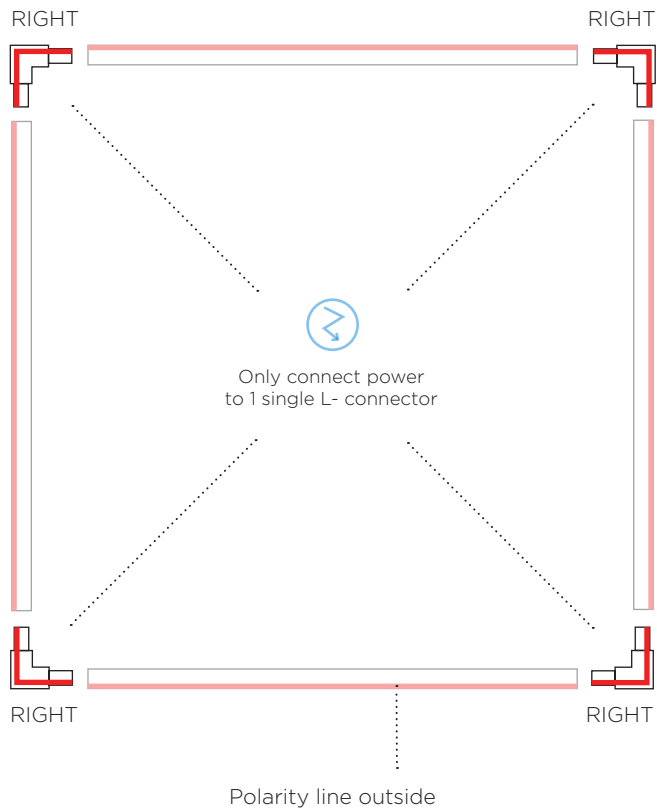

USED COMPONENTS

L-connector

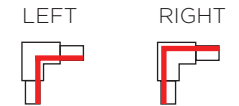

drawings are made in top view

— = indicates ground

 = power connection (220-240VAC)

[Article codes on page 1-3](#)

1 PHASE TRACKS

29-04-2019

HOW TO MAKE A SQUARE? - when the power is located at random (not at one of the corners)

Power can also be connected by using a **middle feed** instead of an L- connector as feeder unit in case the power is located at a more random location.

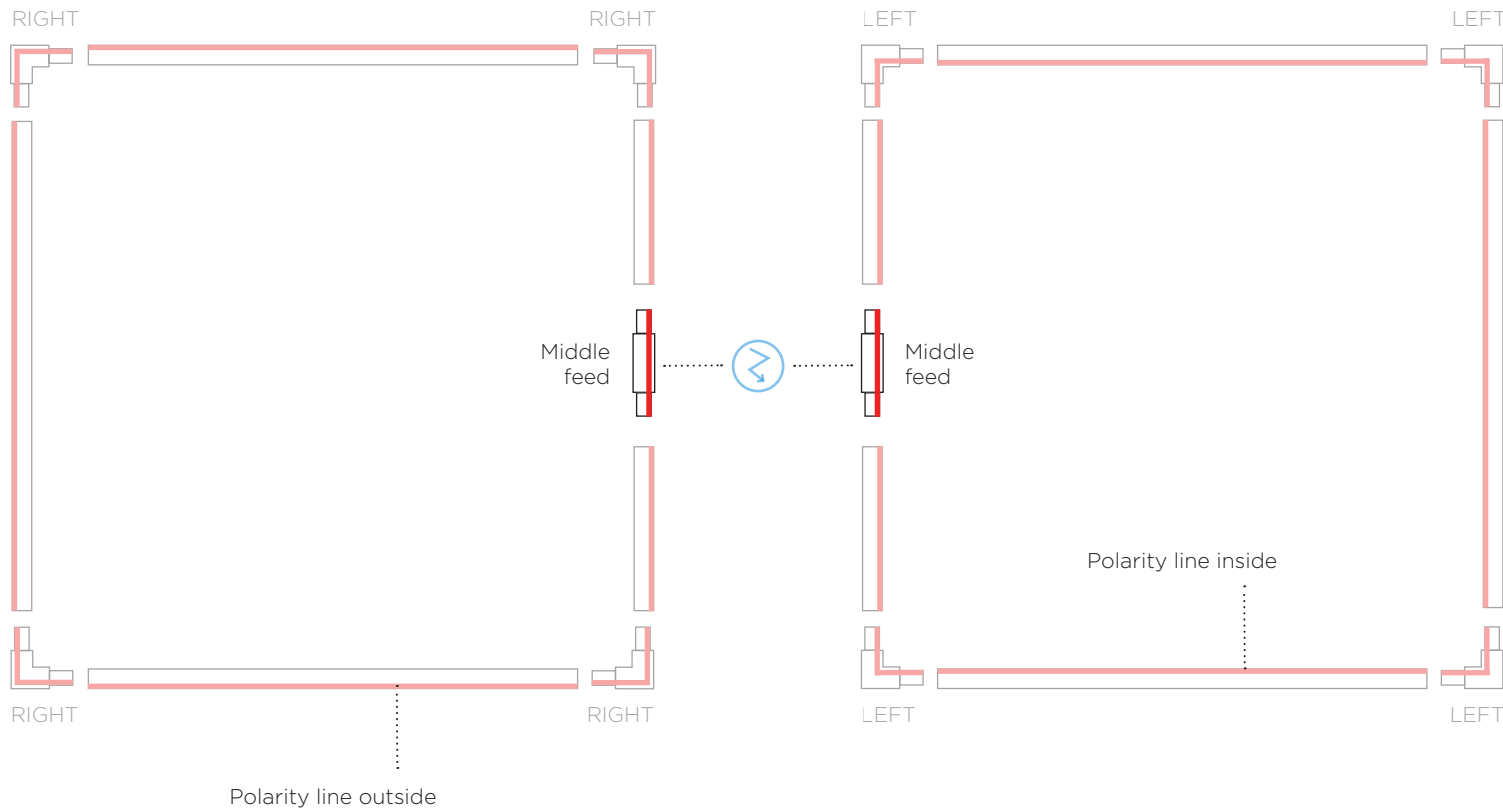

USED COMPONENTS

L-connector

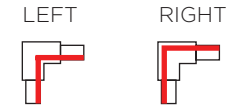

Middle feed



— = indicates ground

 = power connection (220-240VAC)

[Article codes on page 1-3](#)

drawings are made in top view

1 PHASE TRACKS

29-04-2019

HOW TO MAKE A DOUBLE SQUARE?

In this composition each L-connector or T-connector can be used as power feeder unit.

Only connect power to 1 single L- or T- connector per circuit. 

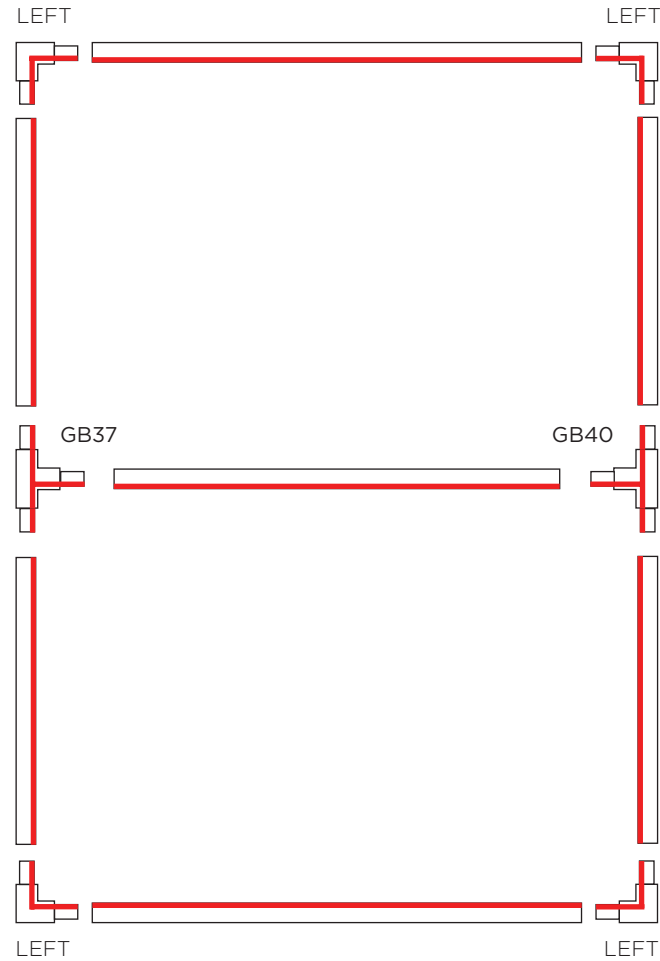
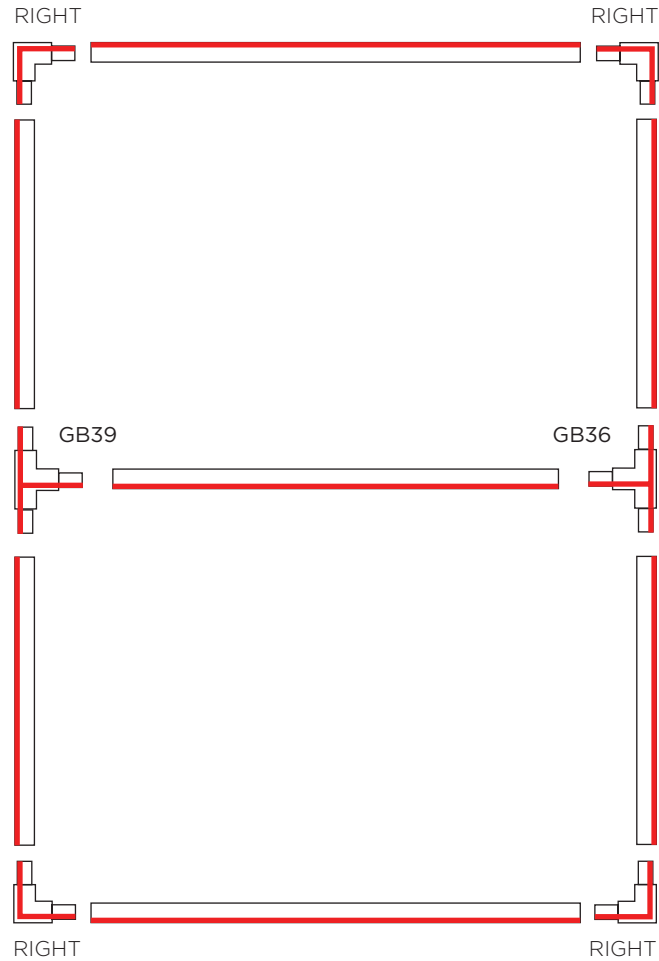

USED COMPONENTS

T-connector

GB40

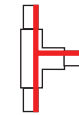

GB39

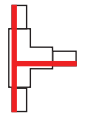

GB37

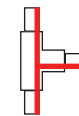

GB36

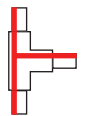

L-connector

LEFT



RIGHT



drawings are made in top view

 = indicates ground

Article codes on page 1-3

1 PHASE TRACKS

29-04-2019

CORRESPONDING T-CONNECTORS

Which different T-connectors can be used with each other (when mirrored)?

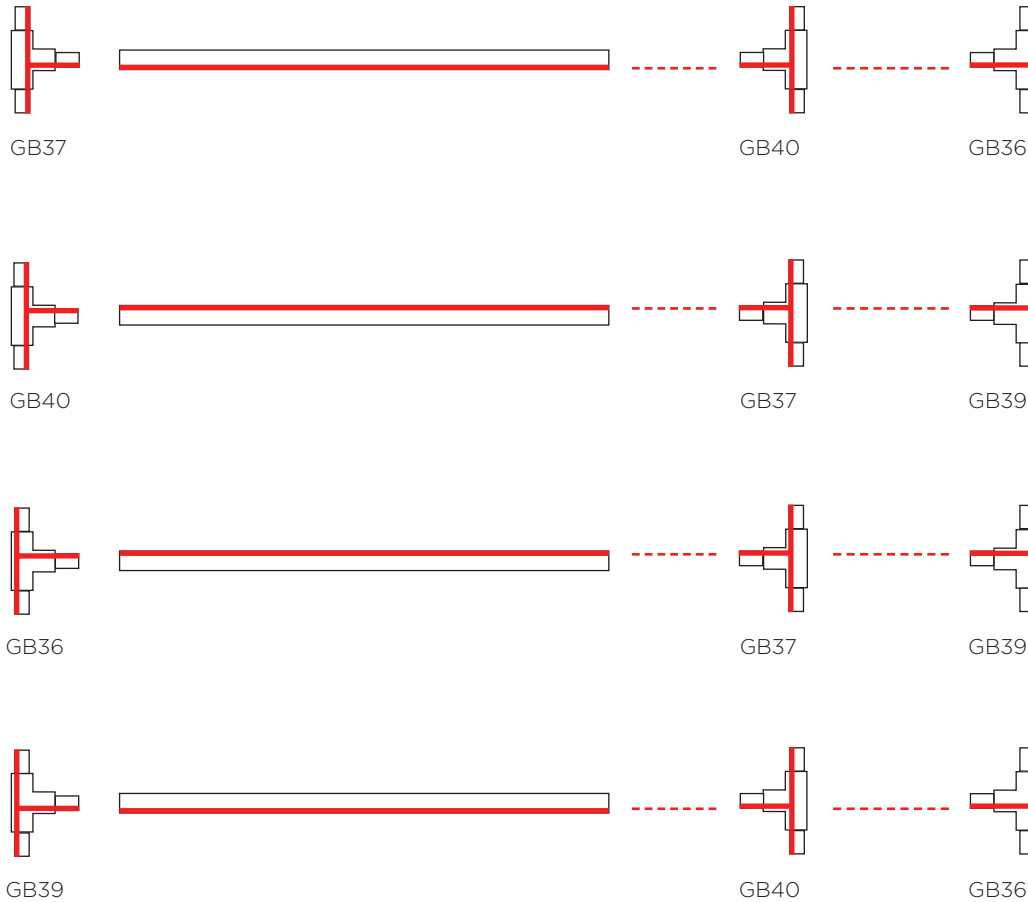

USED COMPONENTS

T-connector

GB40

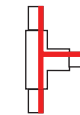

GB39

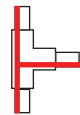

GB37

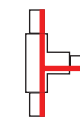

GB36

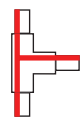

drawings are made in top view

 = indicates ground

 = power connection (220-240VAC)

[Article codes on page 1-3](#)

1 PHASE TRACKS

29-04-2019

HOW TO MAKE A COMPOSITION WITH RANDOM ANGLES? - ADJUSTABLE CORNER

Thanks to the adjustable corner it's possible to make compositions with a wide variety of different angles. (0° - 360°)

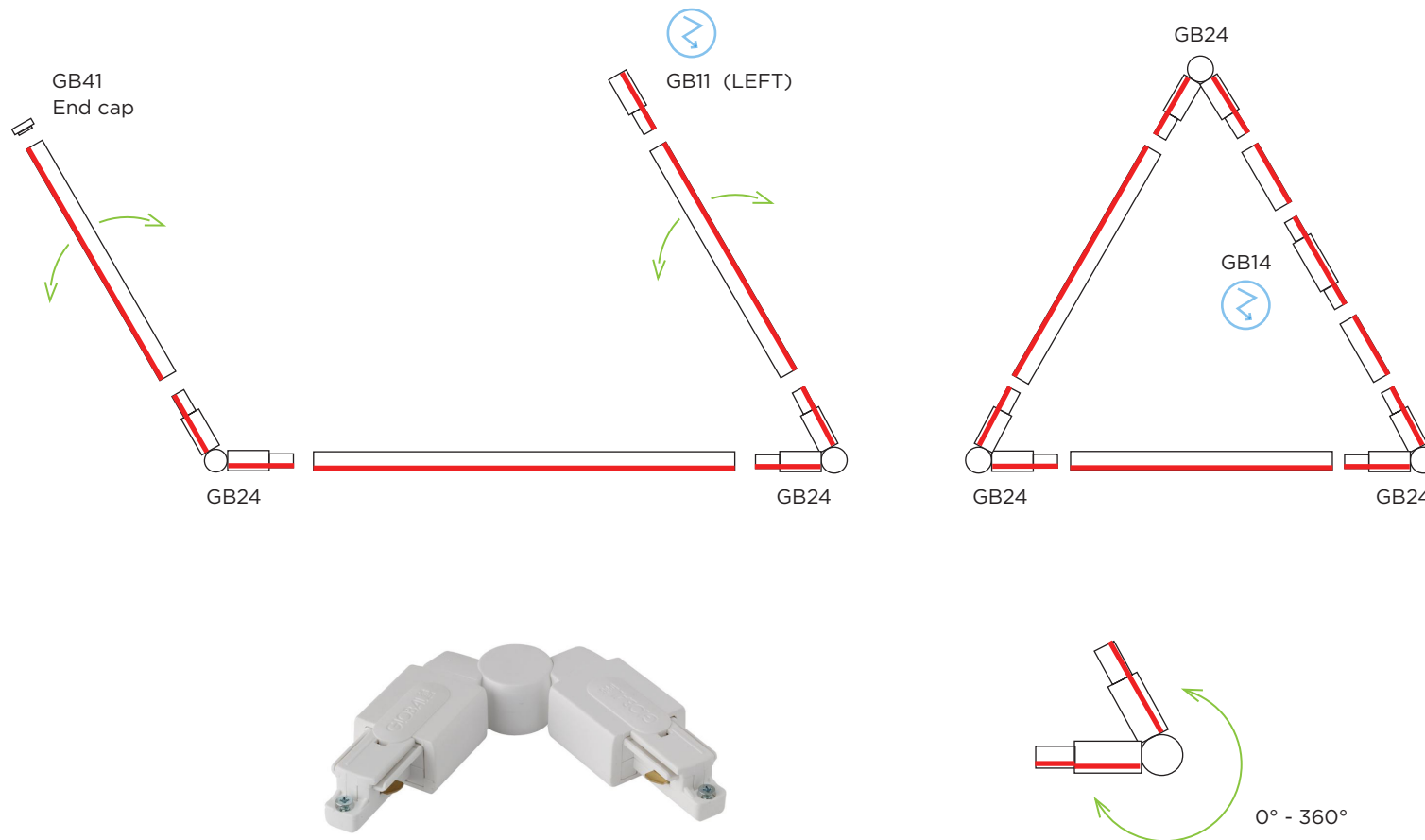

IMPORTANT

As the adjustable corner cannot be used as a power feeder, another feeder unit will be needed; for example an end feed or middle feed to provide electricity.

90° - 180° - 270°

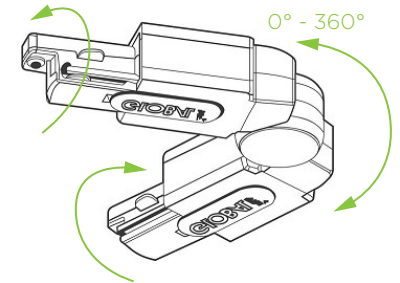

90° - 180° - 270°

 cannot be used as a feeder unit

 = indicates ground

 = power connection (220-240VAC)

Article codes on page 1-3

drawings are made in top view

1 PHASE TRACKS

29-04-2019

HOW TO MAKE A LINE WITH MULTIPLE CORNERS?

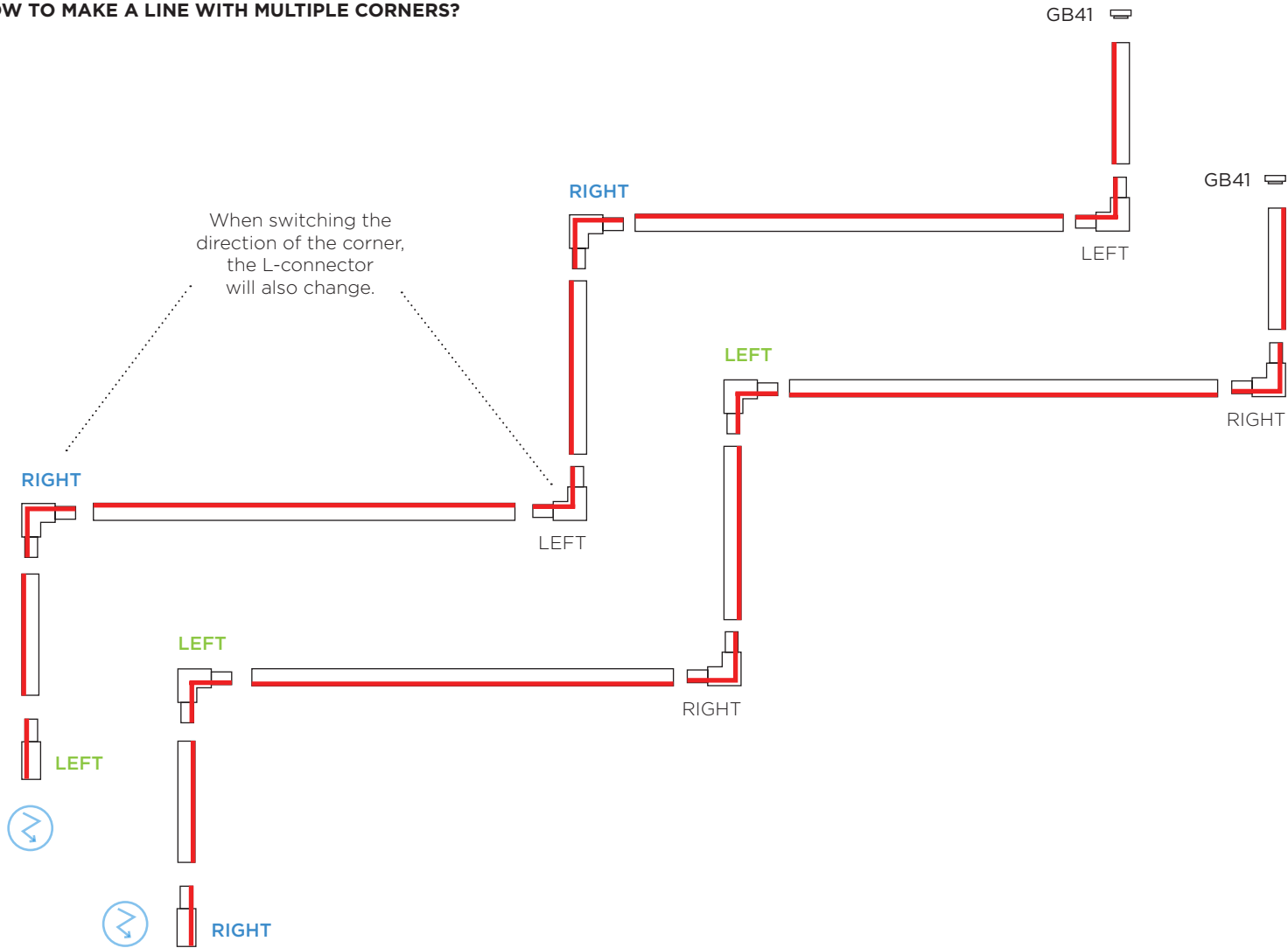

USED COMPONENTS

L-connector

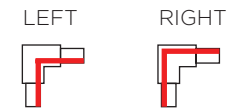

End feed



End cap



— = indicates ground

= power connection (220-240VAC)

Article codes on page 1-3

drawings are made in top view

1 PHASE TRACKS

29-04-2019

MAKING AN "S-COMPOSITION" WITH A MIDDLE FEED

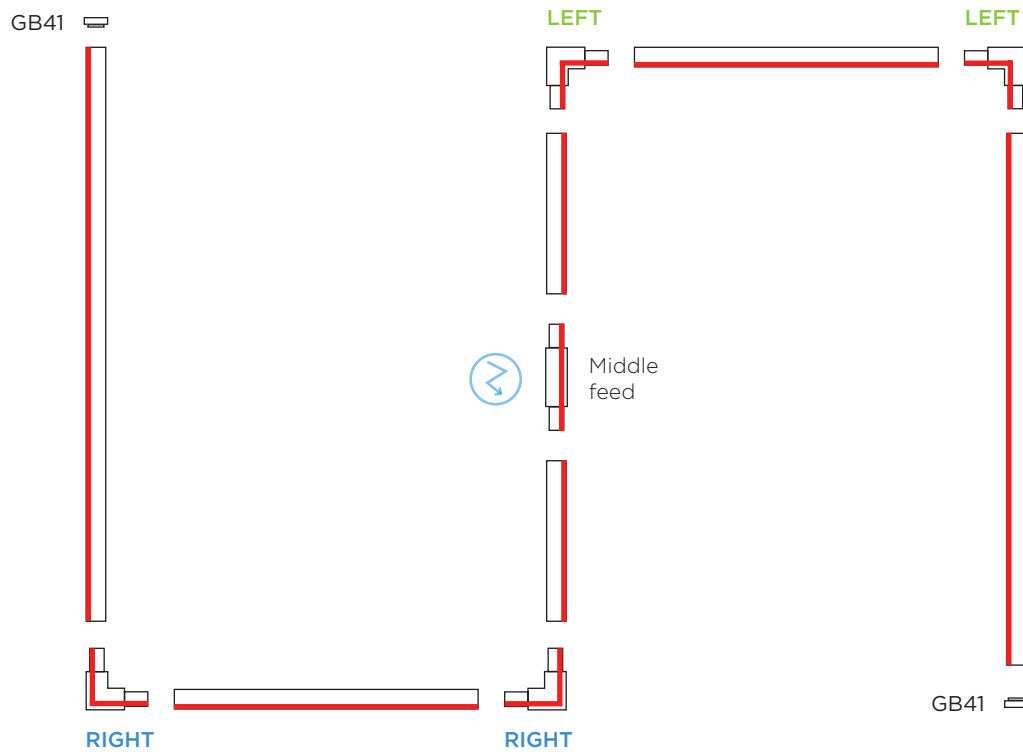

Making a corner in the same direction results in using the same L-connector.

USED COMPONENTS

L-connector

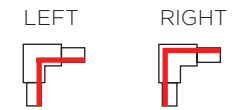



Middle feed



End cap



 = indicates ground

 = power connection (220-240VAC)

drawings are made in top view

[Article codes on page 1-3](#)

1 PHASE TRACKS

29-04-2019

MAKING AN "S-COMPOSITION" COMPARED WITH 2 DIFFERENT END FEEDS

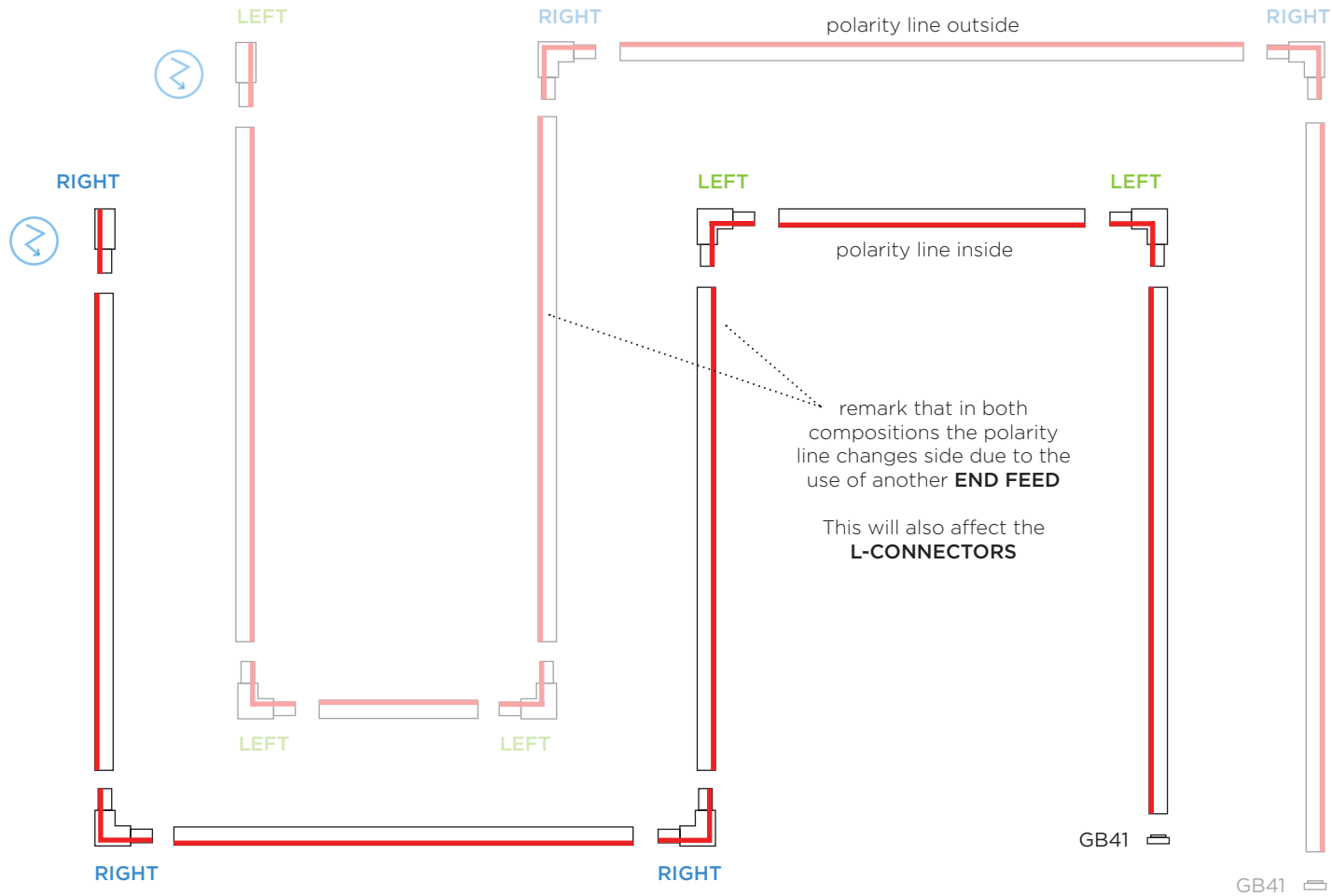

IMPORTANT

In this example we want to show that the same composition can be made in different ways (by using different connectors / feeder units).

Always keep good in mind that this will affect the position of the polarity line like shown in the example.

This will also affect the use of different connectors / feeder units.

L-connector

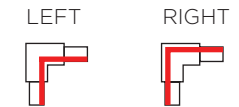

End feed



End cap



— = indicates ground

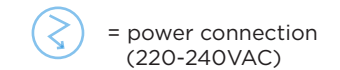

drawings are made in top view

[Article codes on page 1-3](#)

1 PHASE TRACKS

29-04-2019

HOW TO MAKE A CROSS COMPOSITION?

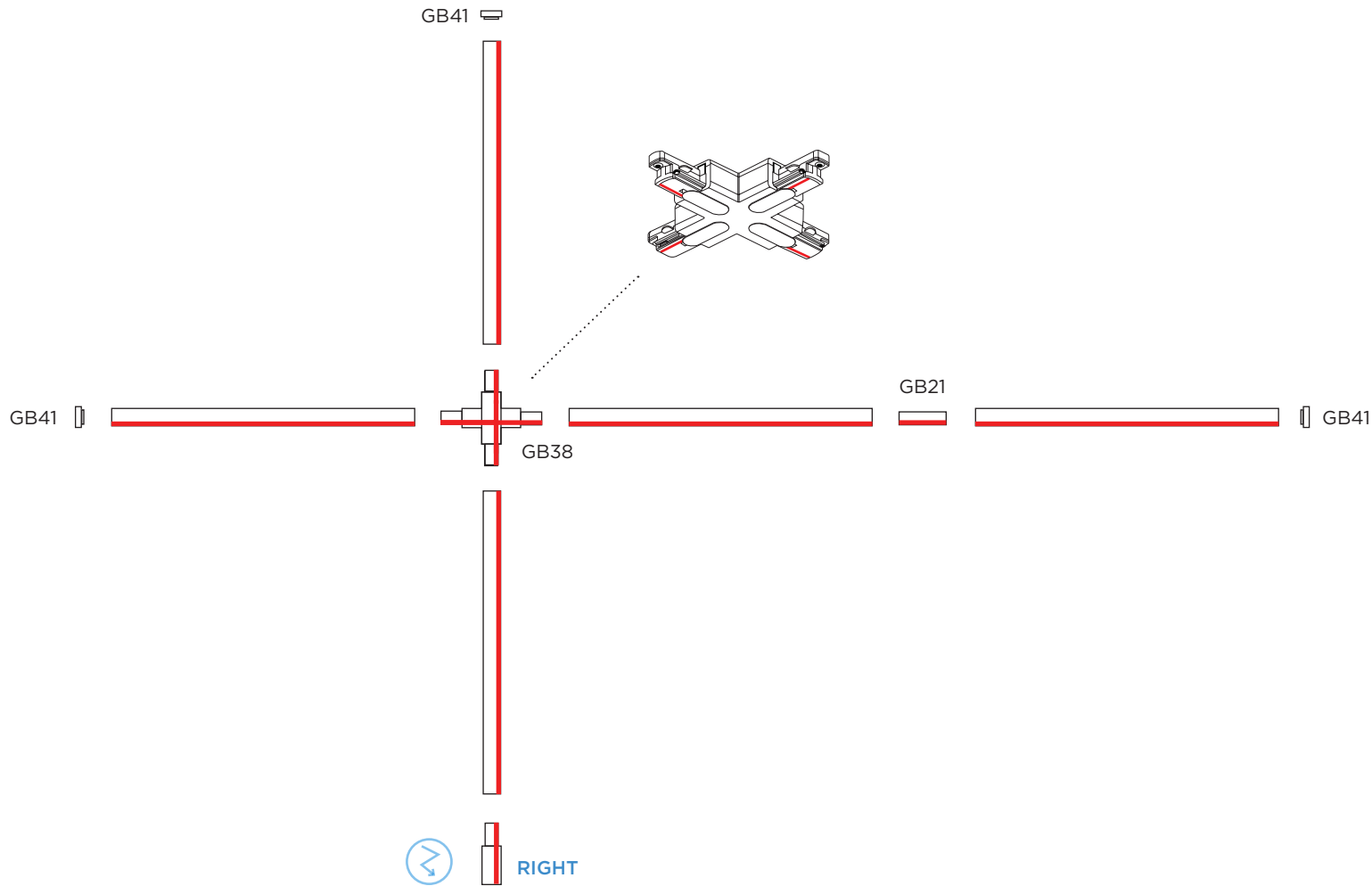

USED COMPONENTS

X-connector



End feed



Straight connector



End cap



— = indicates ground

 = power connection (220-240VAC)

Article codes on page 1-3

drawings are made in top view

1 PHASE TRACKS

29-04-2019

HOW TO SUSPEND A 1 PHASE TRACK?

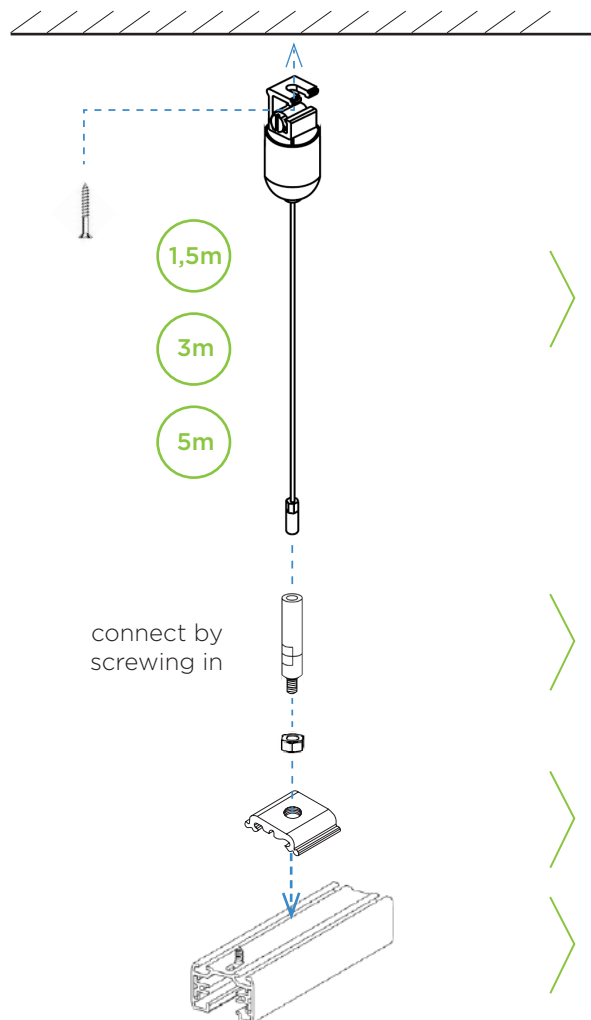

* only ceiling base changes color (white / black)



1F Track

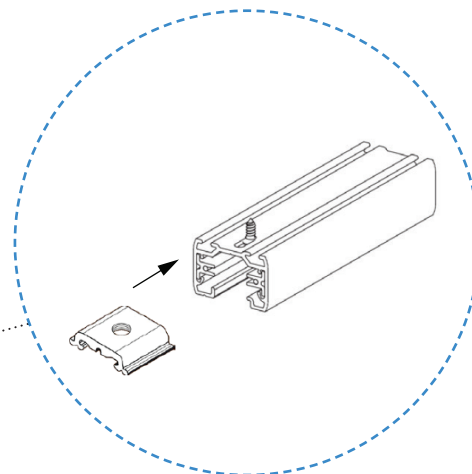



USED COMPONENTS

Wire Suspension





1,5 meter cable set:

-  90014047
-  90014039



OR

3 meter cable set:

-  90014053
-  90014082

OR

5 meter cable set:

-  90014092
-  90014093

Height Adj. Sleeve



-  90014040
- *metal color

Suspension Clamp



-  90014038
- *metal color

1 PHASE TRACKS

29-04-2019

HOW TO SUSPEND A 1 PHASE TRACK?

In order to remain well balanced

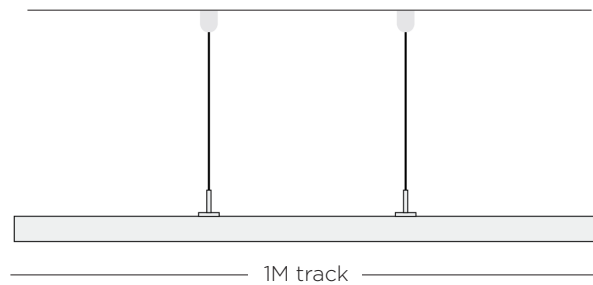

- GENERAL RULE -

meter track + 1 = # suspensions

1M track = 2 suspensions
2M track = 3 suspensions
3M track = 4 suspensions

1M track uses 2 suspensions which divides the track in 3 even distances. $1M / 3 = 33cm$ between the suspensions.

2M track uses 3 suspensions which divides the track in 4 even distances. $2M / 4 = 50cm$ between the suspensions.

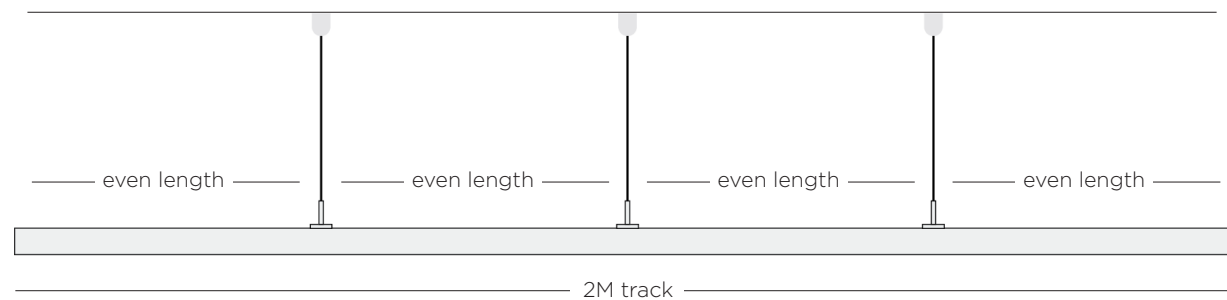

USED COMPONENTS

Suspension set

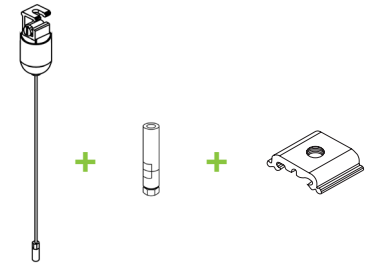

- > feeder unit
- > end cap
- > straight connector (between 2 tracks)

Article codes on page 1 & 18

1 PHASE TRACKS

29-04-2019

GLOBAL 1 PHASE TRACK ADAPTERS - INSTALLATION

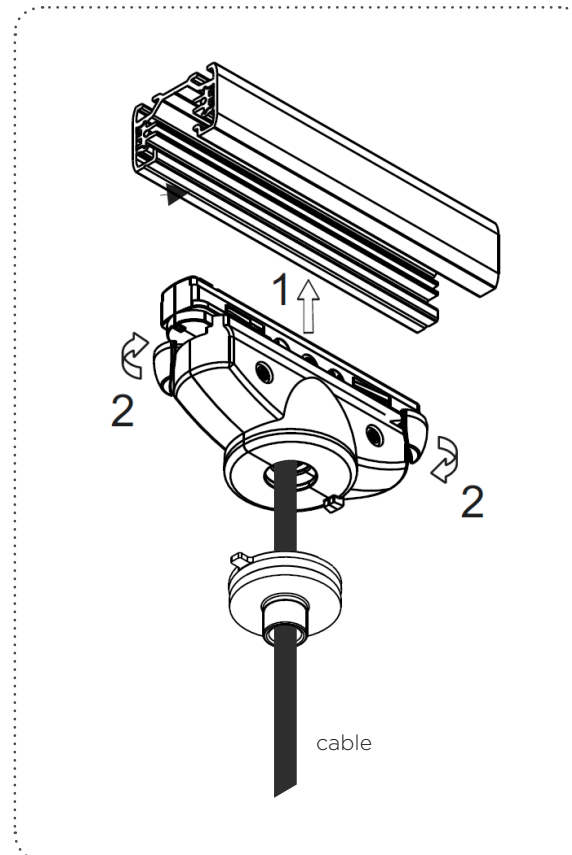
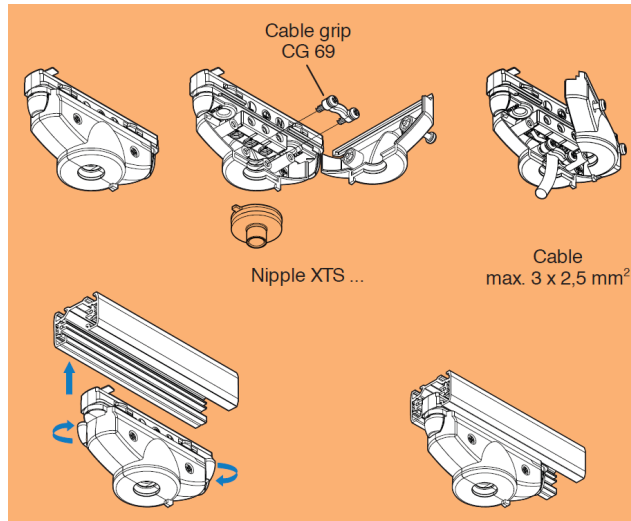

Track adapter
for 1-phase track |
no space for driver

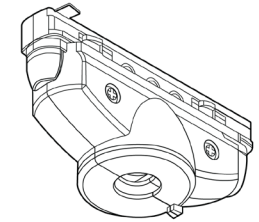

90014044
90014043

Can only be used to mount suspended fixtures on a 1-phase track which don't need a power supply or where the power supply is mounted inside the fixture and not in the ceiling base.

Features:

- > **Max** pull strength 100N (approx. **10kg**)
- > Screw terminals for conductor max 2,5mm²
- > Protection class 1

Article codes on page 3

1 PHASE TRACKS

29-04-2019

HOW TO FIX A 1 PHASE TRACK ADAPTER INTO A 1 PHASE TRACK?

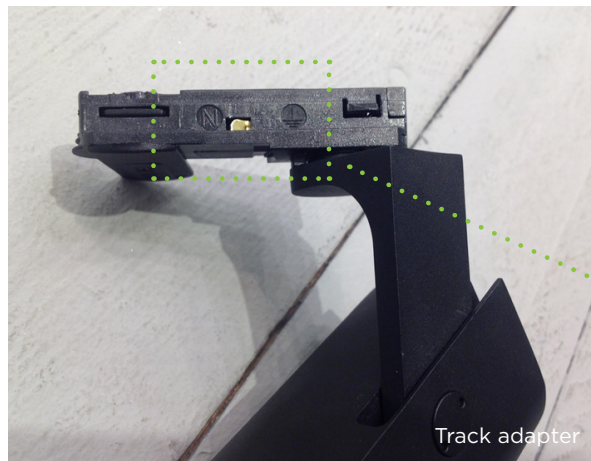
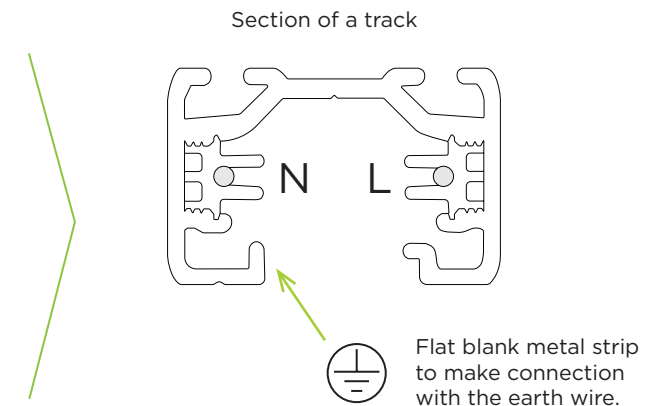
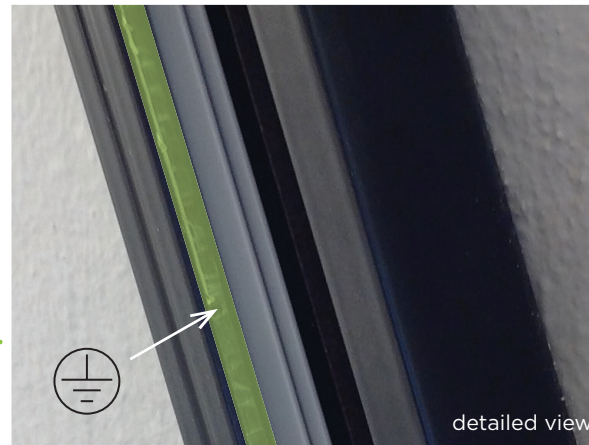

IMPORTANT

Make sure this metal part from the adapter * makes connection to this side of the track (earth wire) in order to mount the track adapter in the correct direction.

When inserting the track adapter in the wrong direction (turned 180°) this will damage the connections of the track adapter.

1 PHASE TRACKS

29-04-2019

HOW TO FIX A 1 PHASE TRACK ADAPTER INTO A 1 PHASE TRACK?

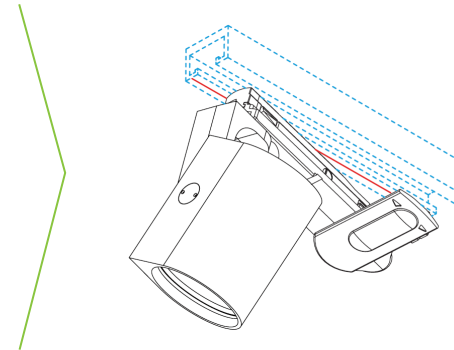
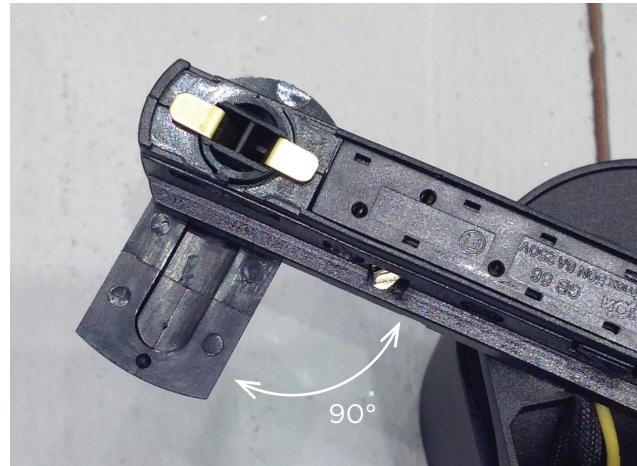

Turn the handle, which is mounted on the adaptor, 90°.

Push the fixture (adaptor) into the track. Make sure the ⊕ icon on the side of the adaptor is faced towards the track side with the black metal strip (small line carved in it)

Make sure that the metal pins are aligned with the track adapter when inserting the adapter into the tracks to avoid damage to these pins (turn handle 90°).

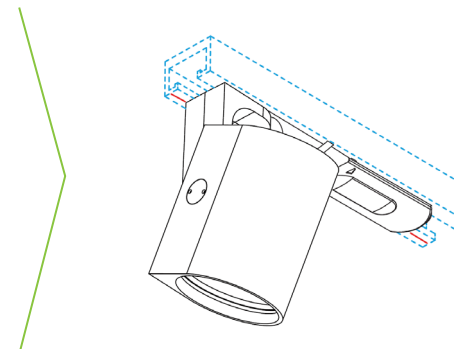
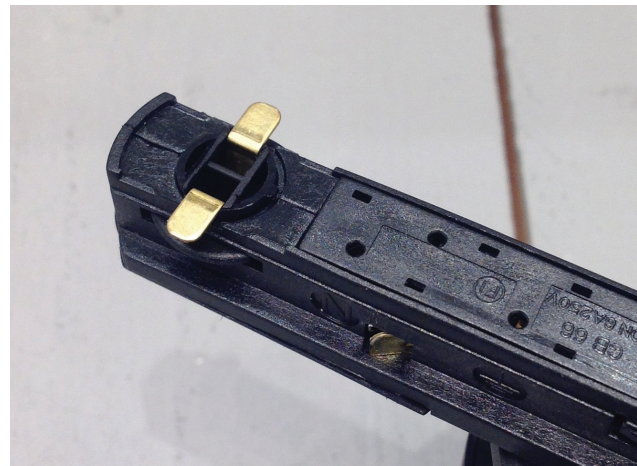

Turn the handle back in its original position. Now both metal pins will make electrical connection to the track and the light will lit up.

When removing the fixture you need to turn the handle again.

1 PHASE TRACKS

29-04-2019

RECESSED TRACKS - OVERVIEW / WHERE TO FIND

Recessed tracks (marked in green) uses exactly the same components as used with the surface mounted tracks. The only difference here is that afterwards coverplates (marked in green) needs to be applied to these components in order to. Recessed tracks are wider than surface mounted tracks due to their trim edge. Using these coverplates will make these components as wide as the track itself.

TRACK PROFILE 1M recessed	TRACK PROFILE 2M recessed	TRACK PROFILE 3M recessed
CODE 90014118 90014119	CODE 90014120 90014121	CODE 90014122 90014123

TRACK PROFILE 1M surface	TRACK PROFILE 2M surface	TRACK PROFILE 3M surface
CODE 90014001 90014007	CODE 90014002 90014008	CODE 90014003 90014009

PAGE 602

COVERPLATE I/L/T/X only use with recessed tracks	COVERPLATE END FEEDS only use with recessed tracks	END FEED left
CODE 90014126 90014127	CODE 90014124 90014125	CODE 90014018 90014019

END FEED right	CONNECTOR straight	L-CONNECTOR LEFT can be used as feed	L-CONNECTOR RIGHT can be used as feed
CODE 90014020 90014021	CODE 90014022 90014023	CODE 90014024 90014025	CODE 90014026 90014027

PAGE 603

1 PHASE TRACKS

29-04-2019

RECESSED TRACKS - COVERPLATES

Coverplates are used to align the (wider) edges from recessed tracks compared to surface mounted tracks, with the standard (small) components (feeders, connectors, etc...) All track components have a standard width which allings perfectly with surface mounted tracks. In order to make them visually as wide as the recessed tracks, coverplates needs to be applied.

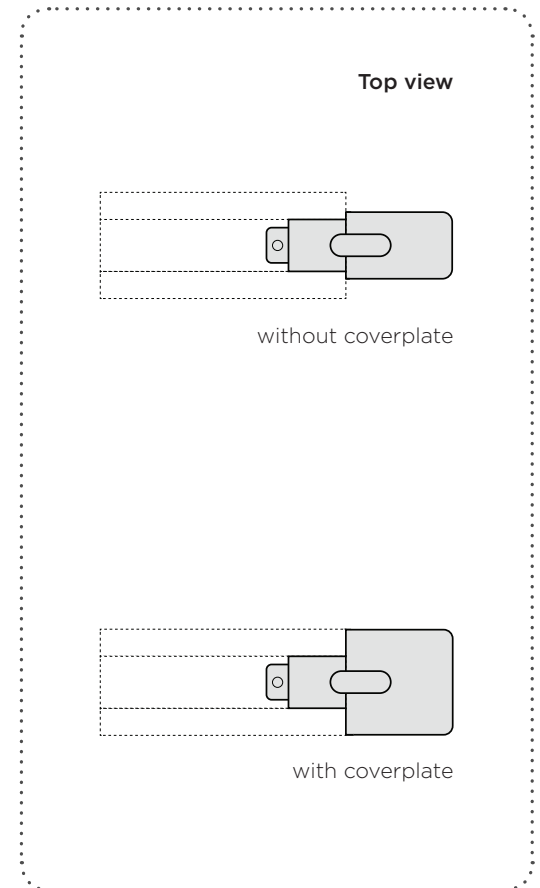
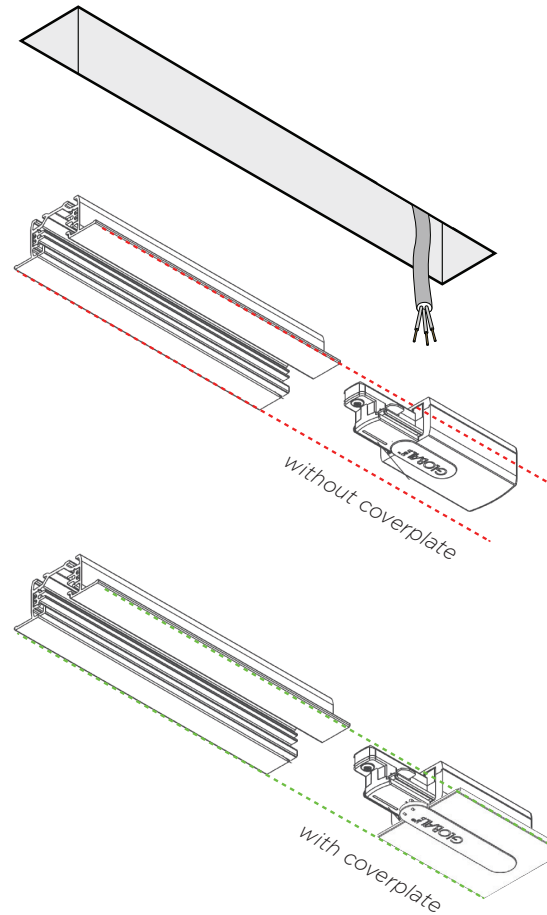
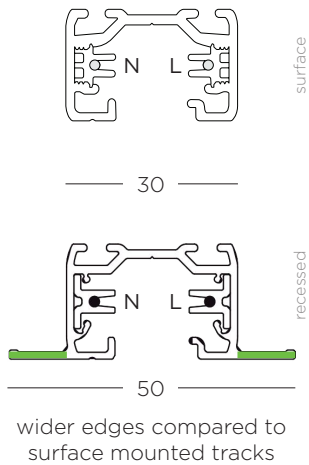

1 PHASE TRACKS

29-04-2019

RECESSED TRACKS - COVERPLATES

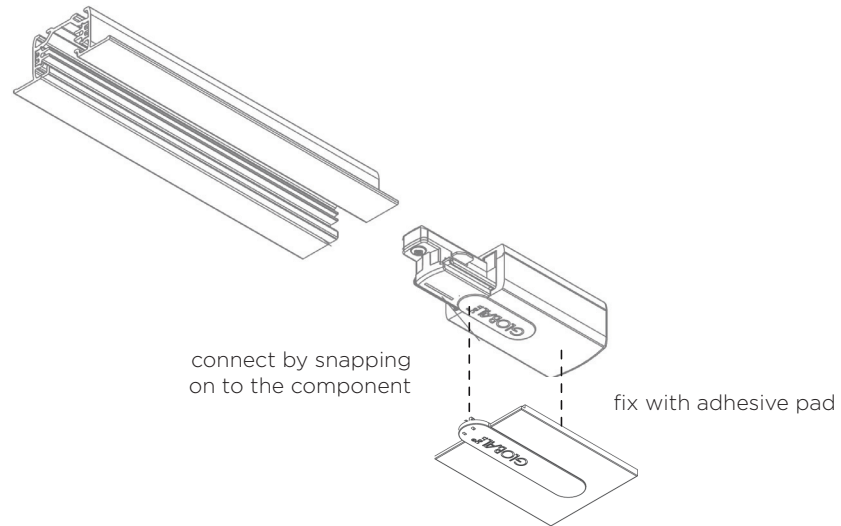

Compatible with:

> End feed (both)

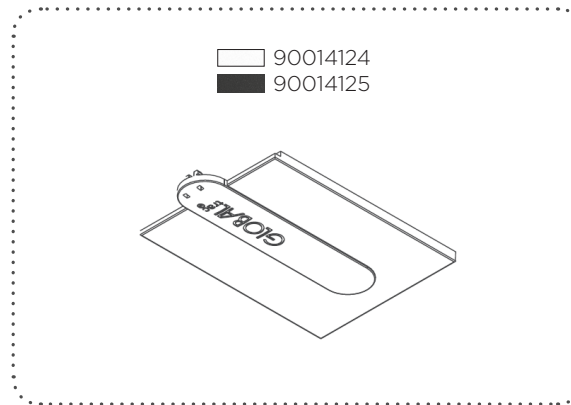

1 PHASE TRACKS

29-04-2019

RECESSED TRACKS - COVERPLATES

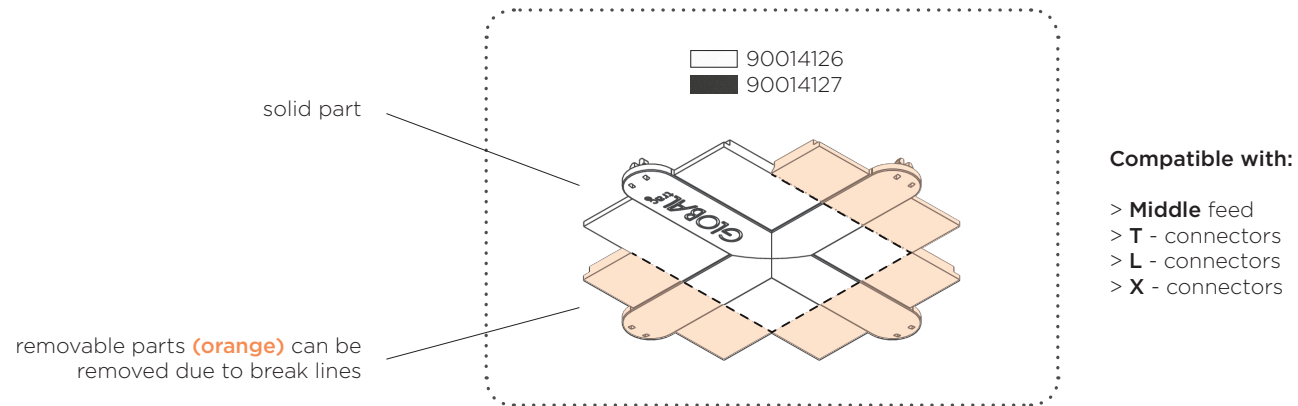
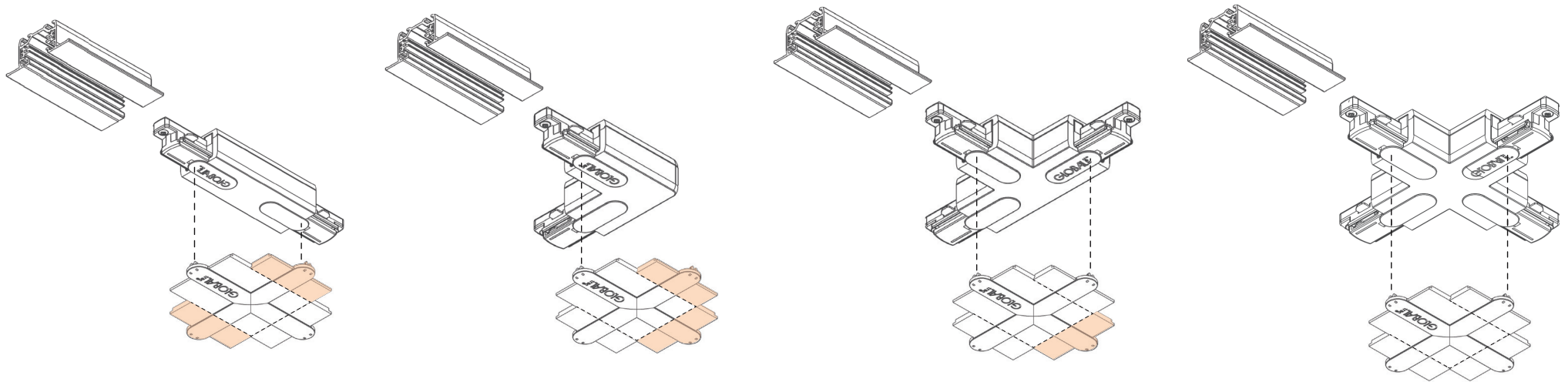

1 PHASE TRACKS

29-04-2019

RECESSED TRACKS - INSTALLATION

Installation - Coverplate:

In order to make the standard components as wide as the recessed tracks (for a nicer visual finish), coverplates need to be fixed to the components. Each coverplate is equipped with small **pins** which fit inside a small **groove** of the component. As you can see on the left picture below, each coverplate is also equipped with an **adhesive pad** for a better and secure fixation.

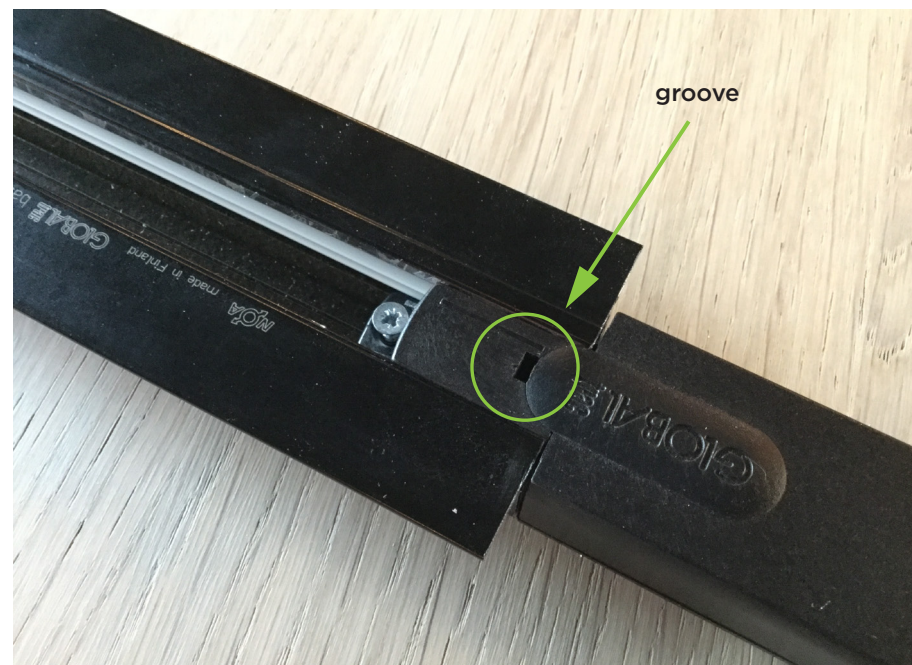
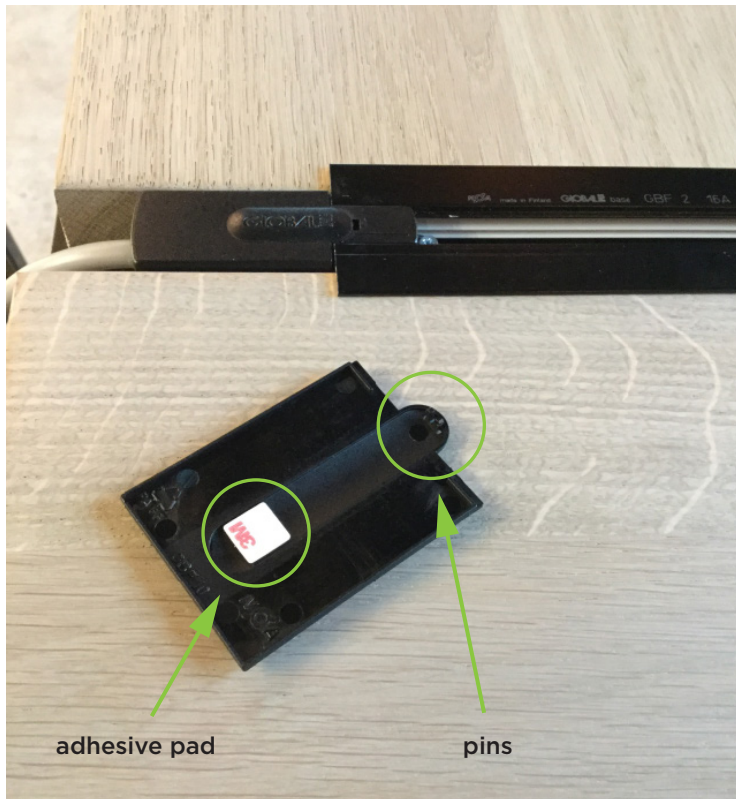

1 PHASE TRACKS

29-04-2019

RECESSED TRACKS - INSTALLATION

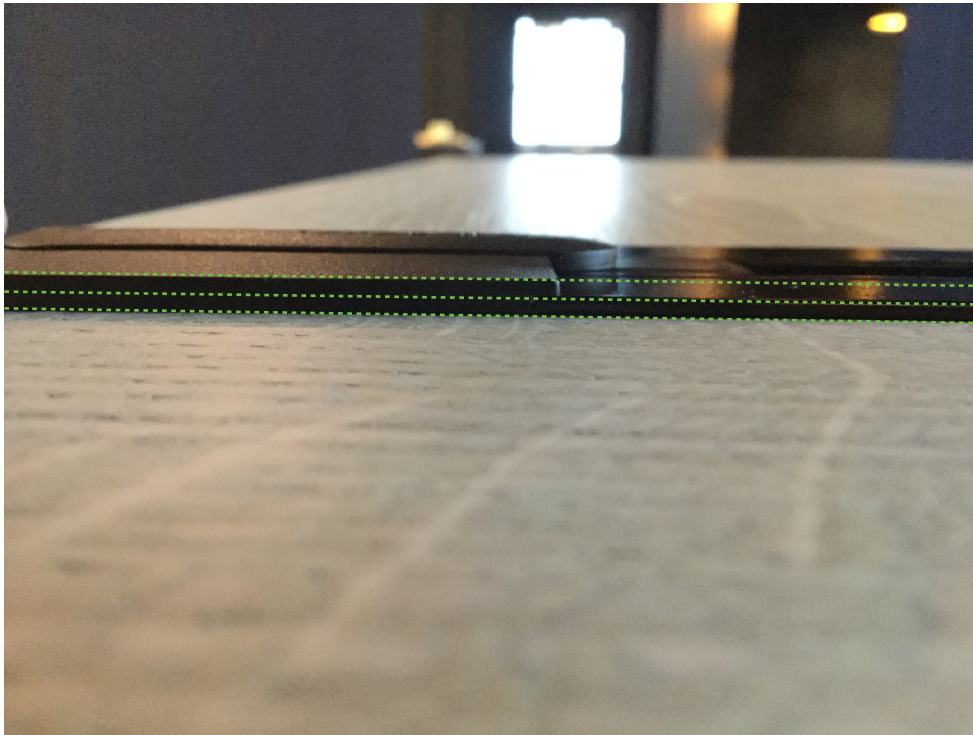

Good to know:

As the picture shows, the coverplate is positioned **on top of** the component / track and can be seen as an extra layer

coverplate
recessed track

on top of track

